

# HD225

## HDTV Projector



Users Manual v1.1

---

**FCC Warning**

Note: This equipment has been tested and found to comply with the limits for a Class B digital device, pursuant to part 15 of the FCC Rules. These limits are designed to provide reasonable protection against harmful interference in a residential installation. This equipment generates, uses and can radiate radio frequency energy and, if not installed and used in accordance with the instructions, may cause harmful interference to radio communications. However, there is no guarantee that interference will not occur in a particular installation. If this equipment does cause harmful interference to radio or television reception, which can be determined by turning the equipment off and on, the user is encouraged to try to correct the interference by one or more of the following measures:

- Reorient or relocate the receiving antenna.
- Increase the separation between the equipment and receiver.
- Connect the equipment into an outlet on a circuit different from that to which the receiver is connected.
- Consult the dealer or an experienced radio/TV technician for help.
- Changes or modifications not expressly approved by Knoll Systems can void the user's authority to operate the equipment.

**Canada**

This Class B digital apparatus complies with Canadian ICES-003.  
Cet appareil numérique de la classe B est conforme à la norme NMB-003 du Canada.

**Safety Certifications**

UL, CUL, TUV, GOST

Other specific Country Approvals may apply. Please see produce certification label.

**Declaration of Conformity**

Knoll Systems, 11791 Machrina Way, Richmond, BC V7A 4V3, Canada

EMC Directive 89/336/EEC, Amended by 93/68/EEC

EMC: EN 55022

EN 55024

EN 61000-3-2

EN 61000-3-3

Low Voltage Directive 73/23/EEC, Amended by 93/68/EEC

Safety: EN 60950: 2000

July 2004

**Trademarks**

Apple, Macintosh, and PowerBook are trademarks or registered trademarks of Apple Computer, Inc. IBM is a trademark or registered trademark of International Business Machines, Inc. Microsoft and Windows are trademarks or registered trademarks of Microsoft Corporation. Adobe and Acrobat are trademarks or registered trademarks of Adobe Systems Incorporated. InFocus, LiteShow, ScreenPlay, and LP are trademarks or registered trademarks of InFocus Corporation. Knoll is a trademark of Pacific Sound & Signal.

**WARNING:** This product contains chemicals, including lead, known to the State of California to cause birth defects or other reproductive harm. ***Wash hands after handling.***

**WARNING:** This product has a lamp, which contains a very small amount of mercury. Dispose of it as required by local, state, or federal ordinances and regulations. For more information, see [www.eiae.org](http://www.eiae.org).

**TABLE OF CONTENTS**

|                                       |    |
|---------------------------------------|----|
| Introduction                          | 5  |
| Positioning the projector             | 6  |
| Video connections                     | 7  |
| Connecting a video device             | 7  |
| Displaying a video image              | 9  |
| Connecting a computer                 | 10 |
| Shutting down the projector           | 11 |
| Troubleshooting your setup            | 11 |
| Using the keypad buttons              | 15 |
| Using the remote control              | 15 |
| Using the audio                       | 16 |
| Customizing the projector             | 16 |
| Optimizing video images               | 17 |
| Using the menus                       | 17 |
| Picture menu                          | 18 |
| Settings menu                         | 21 |
| Maintenance                           | 23 |
| Cleaning the lens                     | 23 |
| Replacing the projection lamp         | 23 |
| Cleaning the dust filters             | 25 |
| Using the security lock               | 25 |
| Red LED behavior and projector errors | 26 |
| Projected image size                  | 26 |

If you are experienced in setting up presentation systems, use the included *Quick Set Up* card. For complete details on connecting and operating the projector, refer to this User's Guide.

## Important Operating Considerations for Safety

- Place the projector in a horizontal position with no greater than 8-degrees forward or backwards tilt.

Do not place objects or people in the 2 foot (.6m) area along the side of the projector. For ceiling mount applications, this area should be 5 feet (1.5m).

- Locate the projector in a well-ventilated area without any obstructions to intake or exhaust vents. Do not place the projector on a tablecloth or other soft covering that may block the vents.

- Locate the projector at least 4' (1.2 m) away from any heating or cooling vents.

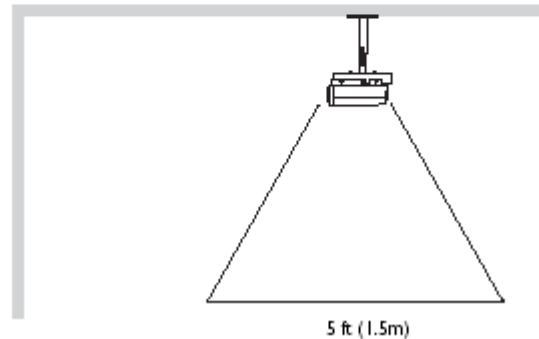
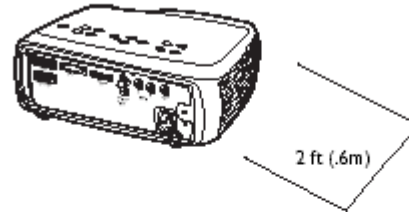
- Use only Knoll-approved ceiling mounts. The minimum distance between the ceiling and a ceiling-mounted projector is 11.8"/30 cm.

- Use only the power cord provided. A surge-protected power strip is recommended.

- Refer to this manual for proper startup and shutdown procedures.

- In the unlikely event of the lamp rupturing, discard any edible items placed in the surrounding area and thoroughly clean the area along all sides of the projector.

- Wash hands after cleaning the area and handling the ruptured lamp. This product has a lamp that contains a very small amount of mercury. Dispose of it as required by local, state or federal ordinances and regulations. For more information see [www.eiae.org](http://www.eiae.org).

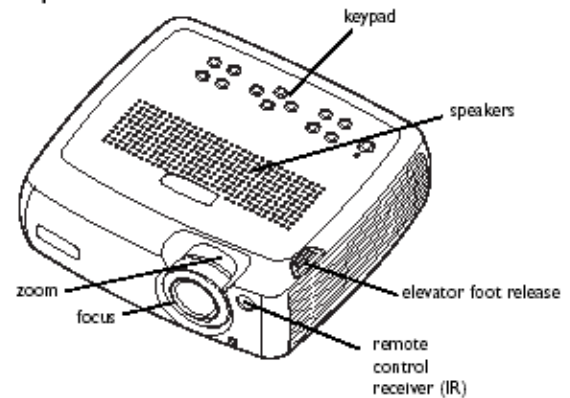


Follow these instructions to help ensure image quality and lamp life over the life of the projector. Failure to follow these instructions may affect the warranty. For complete details of the warranty, see the Warranty section at the end of this User's Guide.

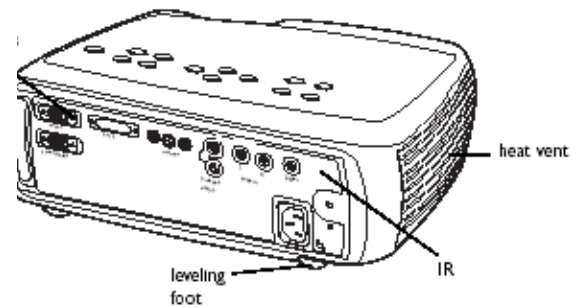
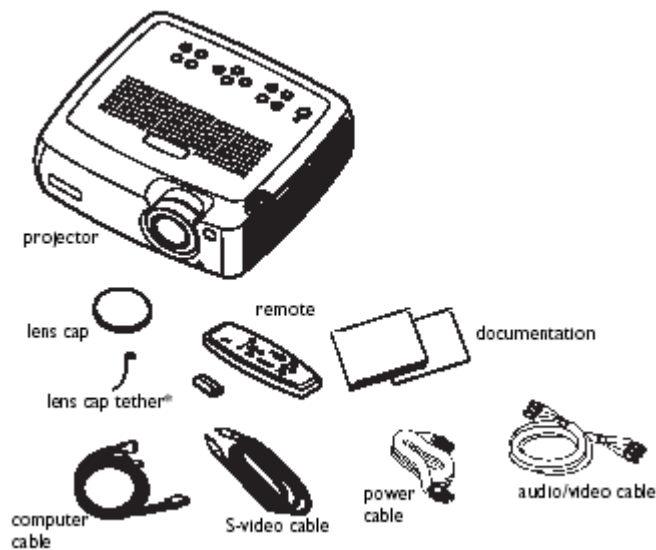
## Introduction

Your new Knoll HD225 projector from Knoll Systems is specifically designed for home cinema applications. It has native 1280x720 resolution. The projector is easy to connect, easy-to-use, and easy to maintain.

### Projector components and features



### Included items



\*The lens cap tether ships in the Documentation Pack. Attach it to the lens cap and the projector if desired.

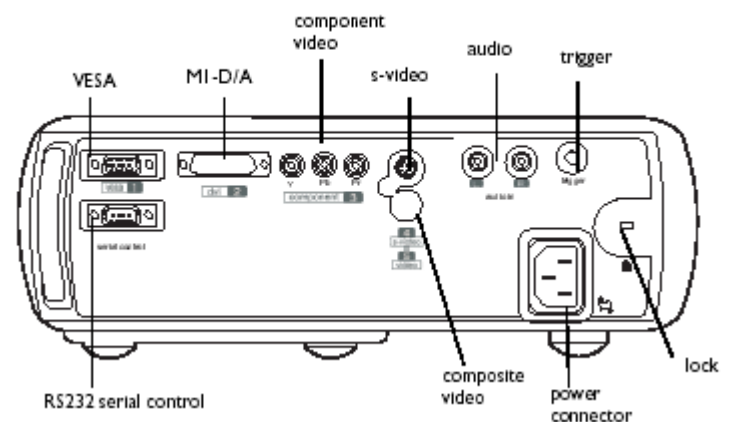
## Connector Panel

The projector provides two computer and four video connectors:

- one M1-D/A (HD, DVI, and computer)
- one VESA (HD, HD component, and computer)
- one S-video
- one composite RCA
- one component video

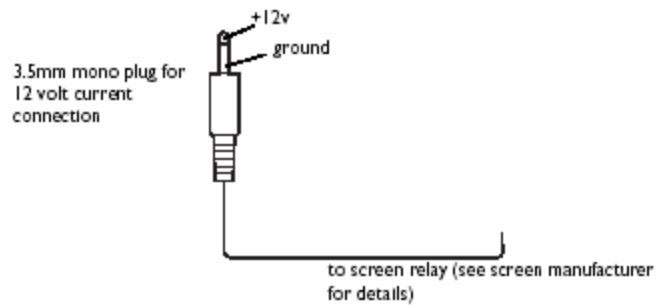
It also has an RS-232 serial connector for serial control. The Command Line Interface (CLI) specifications and commands are on our website.

### Connector panel



A 3.5mm mini-jack trigger provides 12-volt current. This provides a constant output while the projector is on. For example, if you connect your projection screen to the trigger, when you turn on the projector the screen will move down; when you turn the projector off, the screen will return to the storage position.

You must turn the trigger on in the System menu, see page 21.



## Positioning the projector

There are a number of factors to consider when determining where to set up the projector, including the size and shape of your screen, the location of your power outlets, and the distance between the projector and the rest of your equipment. Here are some general guidelines.

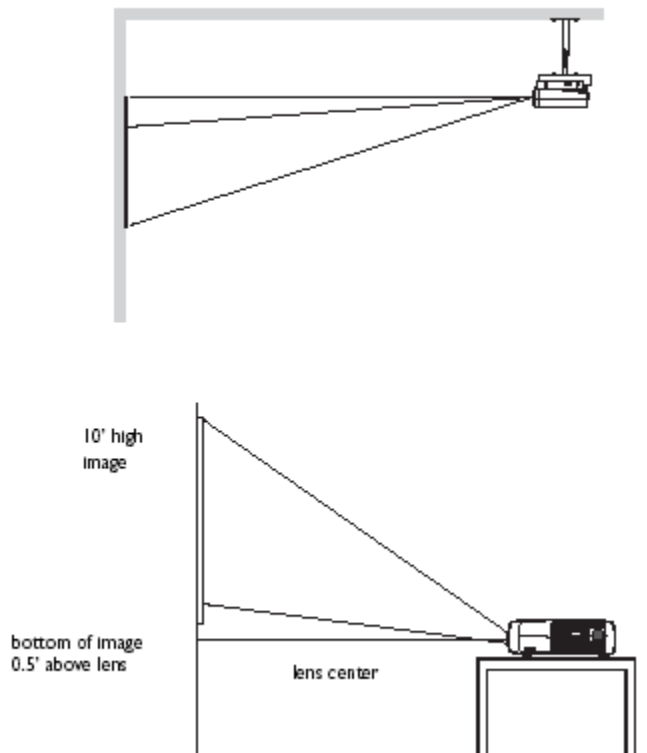
**1** Position the projector on a flat surface at a right angle to the screen. The projector must be within 10 feet (3 m) of your power source. To ensure adequate cable access, place the projector at least six inches (0.15m) from a wall or other objects. Place the projector at least 5.6 feet (1.7 m) from the projection screen.

If you install the projector on the ceiling, refer to the installation guide that comes with the Ceiling Mount Kit for more information. To turn the image upside down, see page 21. Knoll recommends use of an authorized Knoll ceiling mount. The Ceiling Mount Kit is sold separately.

**2** Position the projector the desired distance from the screen.

The distance from the lens of the projector to the screen, the zoom setting, and the video format determines the size of the projected image. For more information about projected image sizes, see page 26.

The image exits the projector at a given angle. This image offset is 105%. This means that if you have an image 10' high, the bottom of the image will be 0.5' above the center of the lens.



Go to [www.knollsystems.com/lcd225.htm](http://www.knollsystems.com/lcd225.htm) for more information.

## Video connections

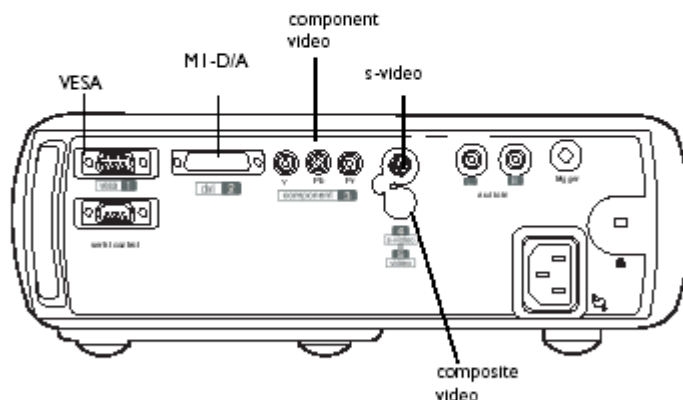
You can connect VCRs, DVD players, camcorders, digital cameras, video games, HDTV receivers, and TV tuners to the projector. (You cannot directly connect the coaxial cable that enters your house from a cable or satellite company; the signal must pass through a tuner first. Examples of tuners are digital cable boxes, VCRs, digital video recorders, and satellite TV boxes.

Basically, any device that can change channels is considered a tuner.) If there is more than one output, select the highest quality one. DVI, Component video and RGB (M1, HD15) have the best quality, followed by S-video, and then composite video.

**Table 1: Video connections**

|            |   |   |
|------------|---|---|
| Video Game | VESA<br>Composite video<br>S-video<br>Component video | VESA 1<br>Video 5<br>S-video 4<br>Component 3 |
|------------|---|---|

NOTE: If you want to use RGB video, see page 8.



**Table 1: Video connections**

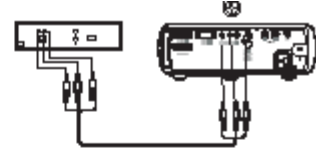
| Input signal   | Connector                                     | Connector label on projector        |
|--|---|-------------------------------------|
| Standard Broadcast TV (not HDTV), via cable, digital cable, satellite TV, DirectTV | Component video<br>S-video<br>Composite video | Component 3<br>S-video 4<br>Video 5 |
| HDTV   | Component video<br>VESA<br>DVI                | Component 3<br>VESA 1<br>DVI 2      |
| DVD  | Component video<br>S-video<br>Composite video | Component 3<br>S-video 4<br>Video 5 |
| VCR  | Composite video<br>S-video<br>Component video | Video 5<br>S-video 4<br>Component 3 |
| Video Camera   | Composite video<br>S-video                    | Video 5<br>S-video 4                |

## Connecting a video device

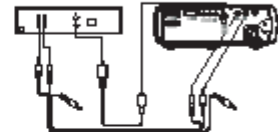
If your video device has more than one output, select the highest quality one. DVI video has the best quality, followed by component video, S-video, and then composite video. If the video device uses component cable connectors, plug the cable's green connectors into the green component-out connector on the video device and into the green component connector (labeled "Y"

**Component 3**) on the projector. Plug the component cable's blue connectors into the blue component-out connector on the video device and into the blue component connector (labeled "Pb") on the projector. Plug the component cable's red connectors into the red component-out connector on the video device and into the red component connector (labeled "Pr") on the projector. If you are using RGB input, plug the additional connector into the **Video 5** connector and turn on the RGB Video option in the Sources menu. See page 21. If the video device uses a round, four-prong S-video connector, plug the S-video cable into the S-video connector on the video device and into the **S-video 4** connector on the projector. Connect the red and white audio connectors from the A/V cable to your source and **Audio In** connector on the projector, if desired.

connect component cable



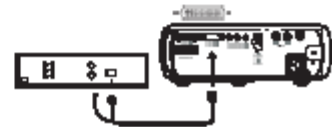
connect S-video cable



connect composite video cable



connect MI-D cable



If the video device uses a yellow composite video connector, plug the A/V cable's yellow connector into the video-out connector on the video device. Plug the other

yellow connector into the yellow **Video 5** connector on the projector. Connect the red and white audio connectors from the A/V cable to your source and the projector. If the video device uses a DVI connector, plug the computer cable into the video-out connector on the video device. Plug the other connector into the **DVI 2** connector on the projector. If the video device uses a VESA connector, plug a VESA cable into the video-out connector on the video device. Plug the other connector into the **VESA 1** connector on the projector.

connect VESA cable



## Connecting the power cable

Connect the power cable to the connector on the back of the projector and to your electrical outlet. The Power button on the keypad lights up and the LED on the keypad turns solid green.

connect power cable



**NOTE:** Always use the power cable that shipped with the projector.



## Displaying a video image

Remove the lens cap.

remove lens cap

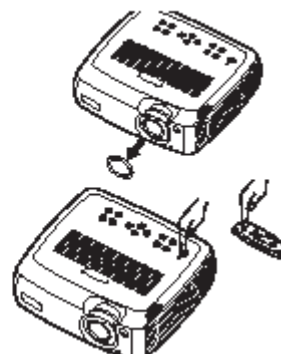


Press the **Power** button on the top of the projector or the remote.

press Power button



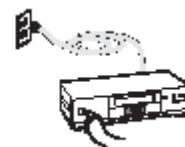
The fans start to run. When the lamp comes on, the startup screen is displayed. It can take a minute for the image to achieve full brightness.



? **No startup screen?** Get help on page 11.

Plug in and turn on the video device.

turn on video device



The video device's image should appear on the projection screen. If it doesn't, press the **Source** button on the keypad or remote.

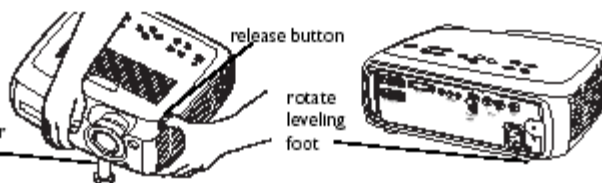
Adjust the height of the projector by pressing the release button to extend the elevator foot. Rotate the leveling foot, if necessary.

adjust height

release button

elevator foot

rotate leveling foot



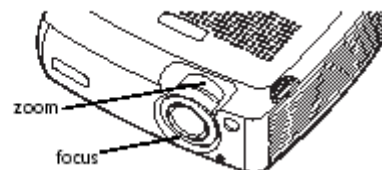
Position the projector the desired distance from the screen at a 90-degree angle to the screen. See 26 for a table listing screen sizes and distances to the screen.

adjust distance



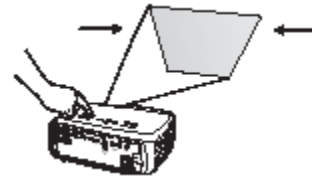
Adjust the zoom or focus rings by rotating them until the desired image size and focus are produced.

adjust zoom and focus

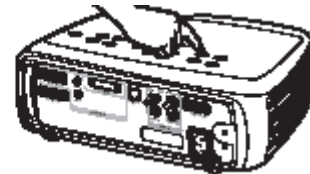


If the image is not square, adjust the vertical keystone using the buttons on the keypad.

Press the upper **Keystone** button to reduce the upper part of the image, and press the lower **Keystone** button to reduce the lower part. You can also adjust the horizontal keystone via the menus, or set the projector to automatically adjust the vertical keystone. See page 17 .



Adjust the volume in the **Audio** menu.



Adjust the **Contrast**, **Brightness**, **Color**, or **Tint** in the Picture menu.



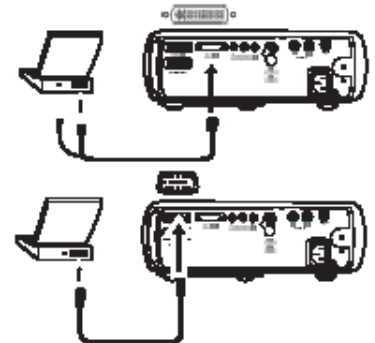
See page 18 for help with the menus.



### Connecting a computer

Connect either a VESA cable or M1 cable into the appropriate connector on the projector (**Vesa 1 or DVI 2**). Connect the other end to the video port on your computer. If you are using a desktop computer, you first need to disconnect the monitor cable from the computer's video port.

connect computer cable



Connect the black power cable to the connector on the back of the projector and to your electrical outlet. The Power LED on the projector's keypad turns solid green.

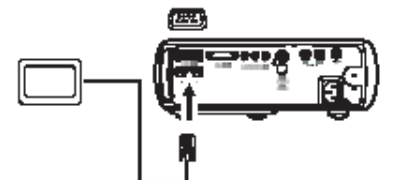
connect power cable



**NOTE:** Always use the power cable that shipped with the projector.

You can control the projector from an LCD control panel or computer by connecting an RS-232 cable to the projector's **Serial control** connector.

connect RS-232 cable



## Shutting down the projector

The projector automatically blanks the screen after no active source is detected for 30 minutes. This blank screen helps preserve the life of the projector.

The image returns when an active source is detected or a remote or keypad button is pressed.

### Screen Save

You can make the blank screen appear after five minutes by turning on Screen Save in the **Settings>System** menu. See page 22. There are six time options for the Screen Save feature. They range from five minutes to 30 minutes with five-minute intervals.

### Power Save

The projector also has a Power Save feature that automatically turns the lamp off after no signals have been detected for five minutes. After three additional minutes with no signal, the projector powers down. If an active signal is received before the projector powers down, the image is displayed. You must press the **Power** button to display an image after 30 minutes have passed. When Power Save is enabled, Screen Save is disabled. See page 22.

### Turning off the projector

To turn off the projector, press the **Power** button. You can cancel the shutdown by pressing the **power** button again within 3 seconds. The lamp turns off and the LED blinks green for one minute while the fans continue to run to cool the lamp. When the lamp has cooled, the LED lights green and the fans stop. Unplug the power cable to completely power off the projector.

## Troubleshooting your setup

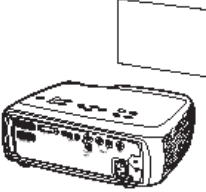
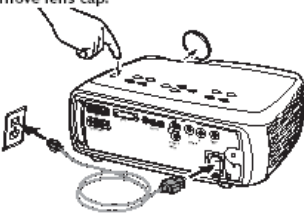
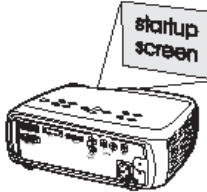
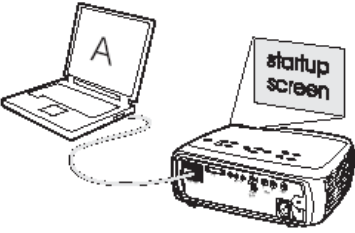

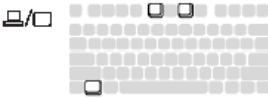
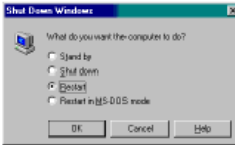
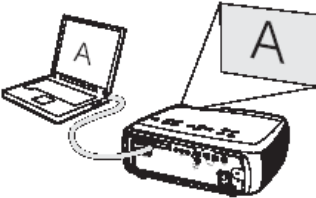
If your image appears correctly on the screen, skip to the next section (page 20). If it does not, troubleshoot the setup. The LED on top of the projector indicates the state of the projector and can help you troubleshoot.

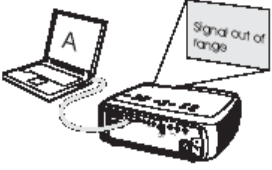

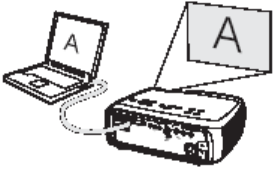



Table 2: LED behavior and meaning

| LED color/behavior                               | Meaning  |
|--|--|
| solid green                                      | The projector is plugged in, or the projector has been turned off and the fans have stopped.   |
| blinking green                                   | The projector is powering down and the fans are running to cool the lamp.  |
| blinking red<br>see page 36 for more information | A fan or lamp failure has occurred. Make sure the vents aren't blocked (see page 17). Turn off the projector and wait one minute, then turn the projector on again. If the Replace Lamp message appears, replace the lamp and reset the lamp timer. Contact Technical Support if the problem persists. |
| solid red  | An unidentifiable error: please contact Technical Support.   |








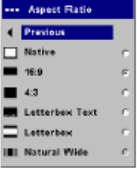

The following tables show common problems. In some cases, more than one possible solution is provided. Try the solutions in the order they are presented. When the problem is solved, you can skip the additional solutions.


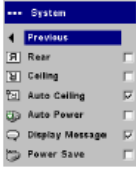


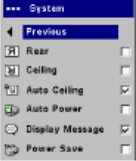

Source Troubleshooting

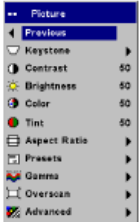
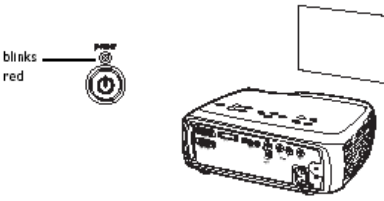
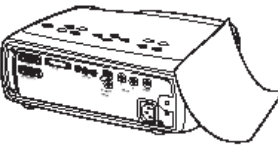
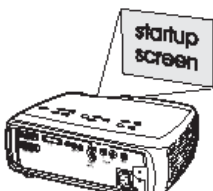
| Problem  | Solution   | Result  |
|--|--|---|
| <p>No startup screen</p>            | <p>Plug power cable in, press Power button.<br/>Remove lens cap.</p>    | <p>Correct image</p>             |
| <p>Only startup screen appears</p>  | <p>Press the Source button <br/>Activate laptop's external port</p>  <p>or restart laptop</p>  | <p>Computer image projected</p>  |

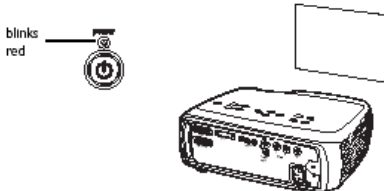
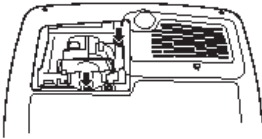
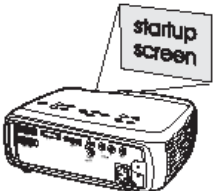
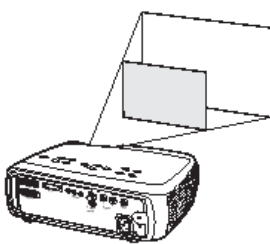
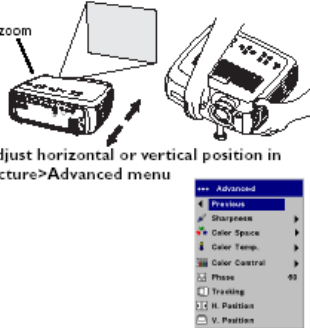
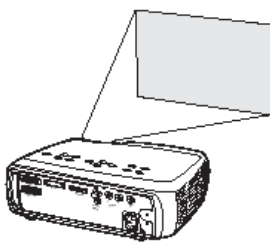
|  |   |   |
|--|---|---|
| <p>No computer image, just the words "Signal out of range"</p>  | <p>Adjust computer refresh rate in Control Panel&gt;Display&gt;Settings&gt;Advanced&gt;Adapter (location varies by operating system)</p>  <p>You may also need to set a different resolution on your computer.</p> | <p>Computer image projected</p>  |
| <p>Edges of image distorted</p>                                 | <p>Turn Overscan on in the Picture&gt;Overscan menu</p>    | <p>Correct image</p>             |

## Projector troubleshooting

| Problem   | Solution   | Result   |
|---|--|--|
| Image not square<br>               | Adjust keystone on keypad or Picture menu<br>                      | Square image<br>  |
| Image not sharp<br>                | Adjust the focus lens or Sharpness in the Picture>Advanced menu<br> | Correct image<br> |
| Image does not fit 16:9 screen<br> | Change aspect ratio to 16:9 in Picture>Aspect ratio menu<br>        | Correct image<br> |

|   |   |  |
|---|---|--|
| Image upside down<br>            | Turn off Ceiling in Settings>System menu<br> | Correct image<br> |
| Image reversed left to right<br> | Turn off Rear in Settings>System menu<br>    | Correct image<br> |

|  |  |   |
|--|--|---|
| <p>1. Projected colors don't match source<br/>2. Colors are washed out or too deep<br/>3. Image from component source appears greenish</p> <p style="text-align: center;"><del>COLOR</del></p> | <p>1. Adjust color, tint, color temperature, brightness, or contrast in the menus.<br/>2. Select another gamma setting<br/>3. Select another color space</p>  | <p>Correct image</p> <p style="text-align: center;">COLOR</p>   |
| <p>Lamp won't turn on, LED blinking red (page 12)</p> <p>blinks red</p>                                       | <p>Make sure vents aren't blocked; allow projector to cool for one minute</p>   | <p>Unplug projector; wait one minute; plug in projector and turn it on: lamp lights</p>  |

|   |   |  |
|---|---|--|
| <p>Lamp won't turn on, LED blinking red (page 12)</p> <p>blinks red</p>  | <p>Lamp must be replaced (page 32)</p>   | <p>Lamp turns on</p>  |
| <p>Image not centered on screen</p>                                      | <p>Move projector, adjust zoom, adjust height</p> <p>Adjust horizontal or vertical position in Picture&gt;Advanced menu</p>  | <p>Correct image</p>  |

**Still having problems?**

If you still need assistance, visit our website or call us. See the inside of the back cover for support contact information. This product is backed by a limited warranty. When sending the projector in for repair, we recommend shipping the unit in its original packing material, or having a professional packaging company pack the unit. Please *insure* your shipment for its full value.

## Using the keypad buttons

Most buttons are described in detail in other sections, but here is an overview of their functions:

**power**—turns the projector on (page 9) and off (page 11).

**menu**—opens the on-screen menus (page 17).

**select**—confirms choices made in the menus (page 17).

**up/down arrows**—navigates to and adjusts settings in the menus (page 17).

**auto image**—resets the projector to the source.

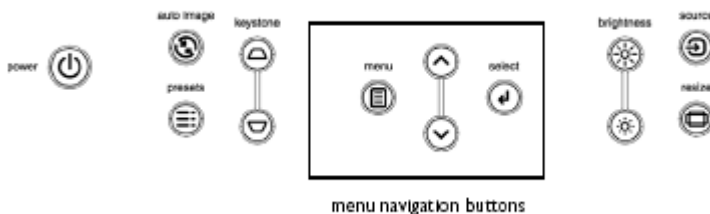
**presets**—cycles through the available preset settings (page 19).

**keystone**—vertical keystone adjusts the squareness of the image (page 18).

**brightness**—adjusts intensity of the image (page 18).

**resize**—changes the aspect ratio (page 18).

**source**—changes the active source (page 9).



## Using the remote control

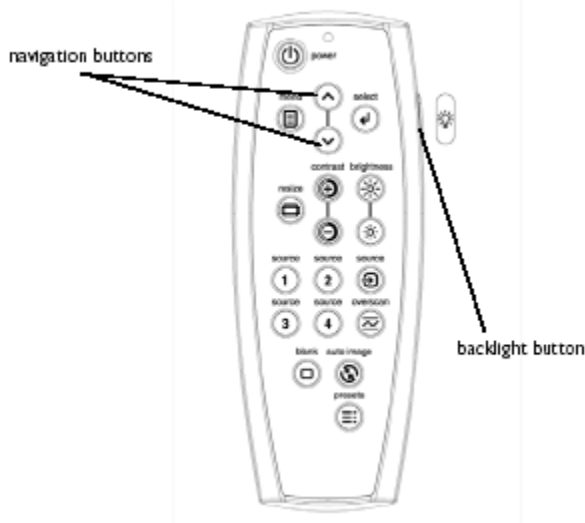
The remote uses two provided AAA batteries. They are easily installed by sliding the cover off the remote's back, aligning the + and - ends of the batteries, sliding them into place, and then replacing the cover.

To operate, point the remote at the projection screen or at the projector (not at the video device or computer). The range of optimum operation is up to 30 feet (9.14m).

Press the remote's **Menu** button to open the projector's menu system. Use the arrow buttons to navigate, and the **Select** button to select features and adjust values in the menus. See page 15 for more info on the menus.

The remote also has:

- **Power** button to turn the projector on and off (see page 11 for shutdown info)
- **Backlight** button to light the remote's buttons in the dark
- **Brightness** and **Contrast** buttons to adjust the image
- **Blank** button to display a blank screen instead of the current image (to change the color of the blank screen, see page 21)



- **Source** buttons to switch among sources (to assign a particular source to a source button, see page 21) and a source toggle
- **Resize** button to change the Aspect Ratio (see page 18)
- **Auto Image** button to resynchronize the projector to the source
- **Preset** button to restore stored settings (see page 19)
- **Overscan** button to remove noise in a video image (page 19)

## Troubleshooting the remote

- Make sure the batteries are installed in the proper orientation and are not dead.
- Make sure you're pointing the remote at the projector or the screen, not at the video device or the computer, and ensure you are within the remote range of 30 feet (9.14m).

## Using the audio

To play sound from the projector, connect your source to the **Audio In** connector on the projector.

connect audio connectors on A/V cable



To adjust the volume, mute or turn off the projector's chime, use the Audio menu (see page 16).

## Troubleshooting audio

If there is no sound, check the following:

- Make sure the audio cables are connected.
- Make sure mute isn't active in the Audio menu.
- Make sure the volume is turned up enough.
- Adjust the audio source.
- If playing a video, make sure the playback has not been paused.

adjust volume



## Customizing the projector

You can customize the projector for your specific setup and needs. See page 21 to page 23 for details on these features.

- For rear projection, turn Rear mode on in the **Settings>System** menu.
- For ceiling mounted projection, turn Ceiling mode on in the **Settings> System** menu.
- Turn on Automatic Vertical Keystone adjustments.
- Specify which source the projector checks first for active video during power-up.
- Turn the projector's display messages on and off.
- Turn on power saving features.
- Specify blank screen colors and startup logos.
- Specify the menu language.
- Control your projector using RS232 commands. See page 5.



## Optimizing video images

After the video device is connected properly and the image is on the screen, you can optimize the image using the onscreen menus. For general information on using the menus, see page 17.

- Adjust the Keystone, Contrast, Brightness, Color, or Tint in the Picture menu. See page 18.
- Change the Aspect ratio. Aspect ratio is the ratio of the image width to image height. TV screens are usually 1.33:1, also known as 4:3. HDTV and most DVDs are 1.78:1, or 16:9. Choose the option that best fits your input source. See page 18.
- Select a Sharpness setting. See page 20.
- Select a different Color Temperature or use the Color Control to adjust the gain and offset of the red, green, and blue color. See page 20.
- Select a specific Gamma or Color Space. See pages 19 and 20.
- Turn Overscan on to remove noise around the video image. See page 19.

## Using the menus

To open the menus, press the **Menu** button on the keypad or remote. (The menus automatically close after 60 seconds, if no buttons are pressed.) The Main menu appears. Use the arrow buttons to move up and down to highlight the desired submenu, then press the **Select** button.

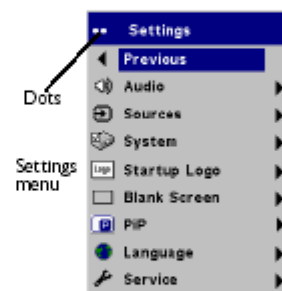
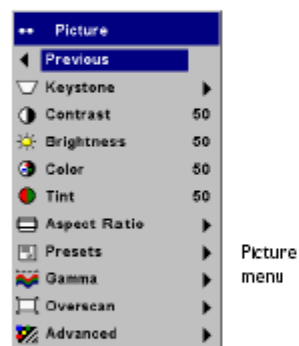
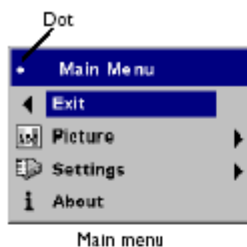
To change a menu setting, highlight it, press **Select**, then use the up and down arrow buttons to adjust the value, select an option using radio buttons, or turn the feature on or off using check boxes. Press **Select** to confirm your changes. Use the arrows to navigate to another setting. When your adjustments are complete, navigate to **Exit**, then press **Select** to go to the previous menu; press the **Menu** button at any time to close the menu.

Dots appear before the menu name. The number of dots indicate the menu's level, ranging from one (the **Main** menu) to four (the most nested menus).

The menus are grouped by usage:

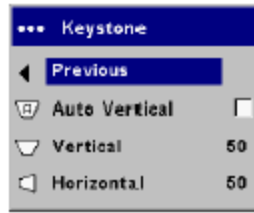
- The Picture menu provides image adjustments.
- The Settings menu provides set-up type adjustments that are not changed often.
- The About menu provides a read-only display of information about the projector and source.

Certain menu items may be grayed out until a particular source is connected. For example, Sharpness is only available for video sources and will be hidden when a computer source is active. Other menu items may be grayed out when they are not available. For example, Brightness is grayed out until an image is active.



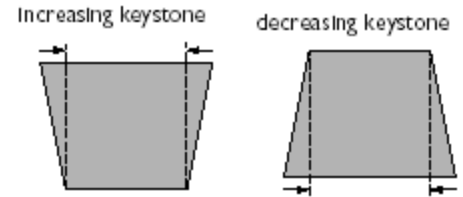
## Picture menu

To adjust the following six settings, highlight the setting, press **Select**, use the up and down arrows to adjust the values, then press select to confirm the changes.



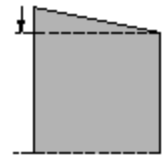
**Vertical Keystone:** adjusts the image vertically and makes a squarer image. You can also adjust vertical keystone from the keypad. If you want the projector to automatically adjust the vertical keystone, check the Auto Vertical check box.

Vertical Keystone



**Horizontal Keystone:** adjusts the image horizontally and makes a squarer image.

Horizontal Keystone



**Contrast:** controls the degree of difference between the lightest and darkest parts of the picture and changes the amount of black and white in the image.

**Brightness:** changes the intensity of the image.

**Color:** (video and component sources only) adjusts a video image from black and white to fully saturated color.



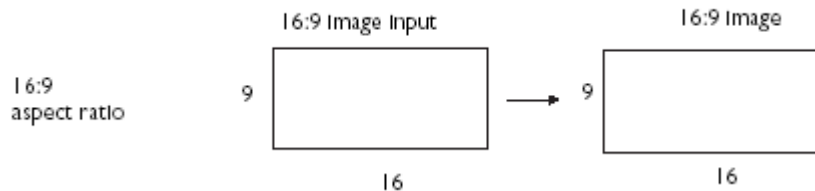
Aspect Ratio

**Tint:** (NTSC video sources only) adjusts the red-green color balance in the image.

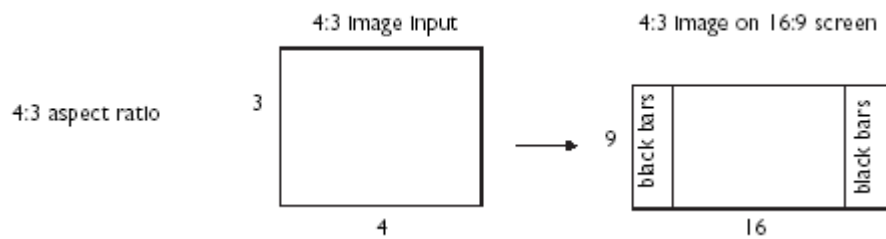
**Aspect Ratio:** aspect ratio is the ratio of the image width to image height. TV screens are usually 1.33:1, also known as 4:3. HDTV and most DVDs are 1.78:1, or 16:9. The default is 16:9.

**Native:** this mode bypasses the internal scaler, displaying the image with no resizing. Since the native resolution is 1280x720 and 4x3 video images are approximately 640x480, 4x3 images will always be smaller than the display and will be centered in the display. Computer images 1024x768 or smaller will also be centered in the display. If a 16x9 video source or a 1280x1024 or larger computer source is viewed, it will display up to 1280 pixels and 720 lines from the center of the input.

**16:9:** the default is **16:9**, which preserves the 16:9 aspect ratio and is designed to be used with content that is enhanced for widescreen TVs.

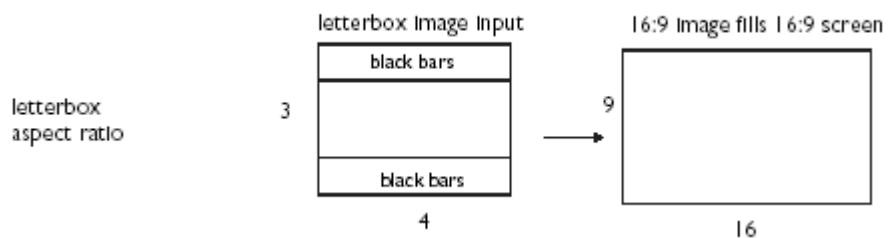


**4:3:** resizes the image from its original version to fit a standard 4:3 aspect ratio screen. If you have a 4:3 source on a 16:9 screen, the image is placed in a 16:9 space, so black bars appear at the sides of the image.

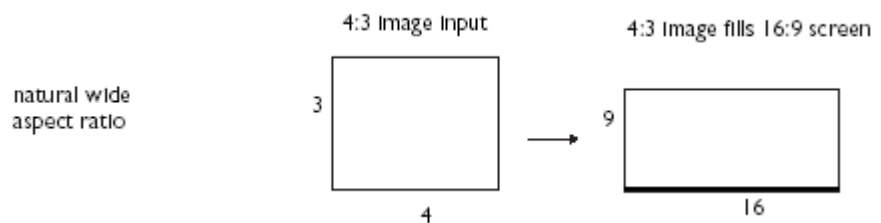


**Letterbox text:** preserves the 16:9 aspect ratio and maximizes readability of the text.

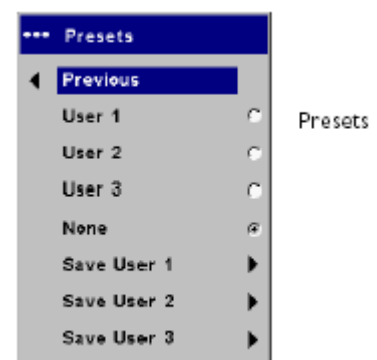
**Letterbox:** preserves the 16:9 aspect ratio. If you have a 16:9 source and screen, the image fills the screen. If your source is letterboxed, the image is expanded to fill the screen.



**Natural Wide:** this mode stretches a 4:3 image to fill the entire 16:9 screen. The center two-thirds of the image is unchanged; the edges of the image are stretched.



**Presets:** You can customize the settings for each source and save them as a preset. There are three user-definable presets. To set a preset for the current source, adjust the image; then choose Save User 1, 2, or 3. You can recall these settings in the future by selecting the appropriate user presets.

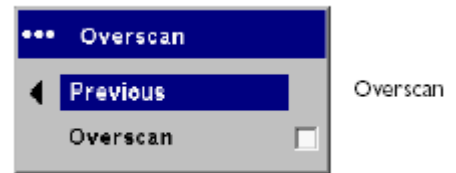


**Gamma:** Gamma tables contain preset intensity configurations optimized for the input source. You can select a gamma table that has been specifically tuned for film, presentation, or photography.

**NOTE:** Your viewing preferences may vary. Cycle through the gamma options and pick the one you like the best.

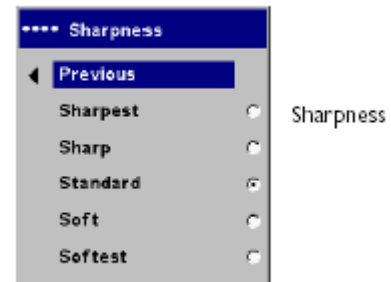


**Overscan:** (video sources only) removes noise around the video image.

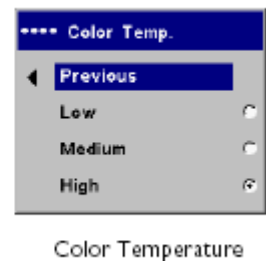
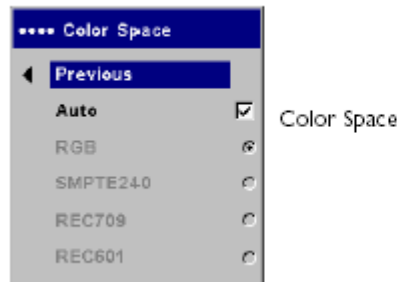


## Advanced settings

**Sharpness:** (video sources only) changes the clarity of the edges of a video image. Select a sharpness setting.



**Color Space:** This option applies to computer sources. It allows you to select a color space that has been specifically tuned for the video input. When Auto is selected, the projector automatically determines the standard. To choose a different setting, turn off Auto, then choose RGB for computer sources, choose either SMPTE240, REC709 or REC601 for component sources.



**Color Temperature:** changes the relative warmth of the colors.

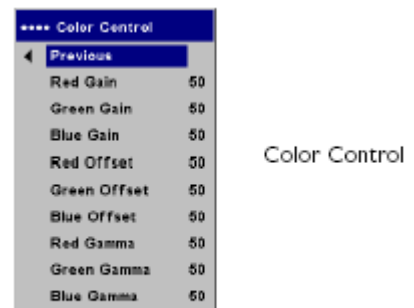
**Color Control:** allows you to individually adjust the gain (intensity of the color), the offset (the amount of black in the color), and the gamma of the red, green, and blue colors.

The following four options are for computer and component sources only.

**Phase:** adjusts the horizontal phase of a computer source.

**Tracking:** adjusts the vertical scan of a computer source.

**Horizontal/Vertical Position:** adjusts the position of a computer source.



## Settings menu

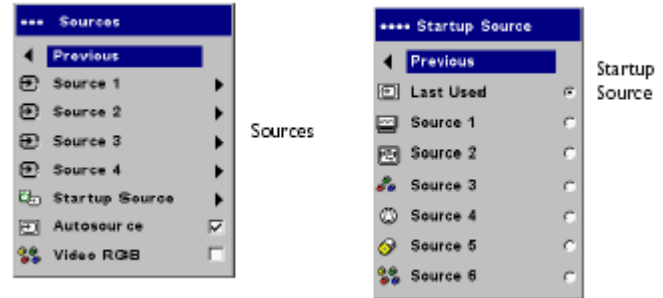
**Audio:** allows adjustments to the volume and mute, and turns the projector's startup Chime on and off.



**Sources:** allows you to assign a particular input to a specific source key on the remote. Also allows selection of a default Startup Source and enables or disables Autosource and RGB Video.

**Sources>Startup Source:** this determines which source the projector checks for first for active video during power-up.

**Sources>Autosource:** When Autosource is not checked, the projector defaults to the source selected in Startup Source. If no source is found, a blank screen displays. When Autosource is checked, Startup Source determines which source the projector defaults to at power-up. If no signal is present, the projector checks the sources in order until a source is found or until power-down.



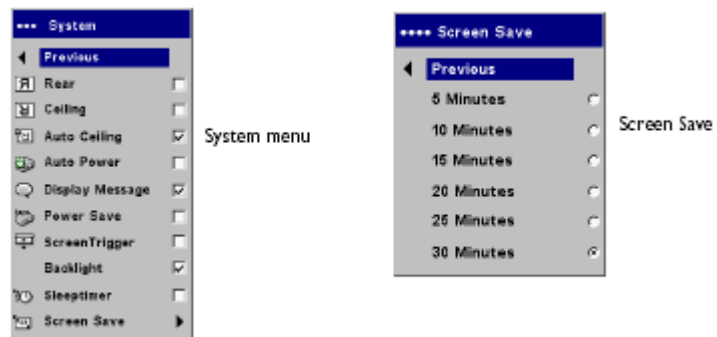
**Sources>RGB Video:** check this box if you are using a DVD player with RGB output.

**System>Rear:** reverses the image so you can project from behind a translucent screen.

**Ceiling:** turns the image upside down for ceiling-mounted projection.

**Auto Ceiling:** automatically senses when the projector is inverted and turns the image upside down. This is "On" by default.

**Auto Power:** When Auto Power is checked, the projector automatically goes into the startup state after the projector is powered on. This allows control of ceiling mounted projectors with a wall power switch.



**Display Messages:** displays status messages (such as "Searching" or "Mute") in the lower-left corner of the screen.

**Power Save:** automatically turns the lamp off after no signals are detected for five minutes. After three additional minutes with no signal, the projector powers down. If an active signal is received before the projector powers down, the image will be displayed.

**Screen Trigger:** turns on the 12-volt DC output switch on the connector panel.

**Backlight:** allows you to turn off the backlighting on the keypad.

**Sleep Timer:** allows you to force the projector to automatically shutoff after 4 hours.

**Screen Save:** automatically blanks the screen with a black color after no signals are detected for a preset number of minutes. The image returns when an active source is detected or a remote or keypad button is pressed. Screen Save is disabled when Power Save is enabled.

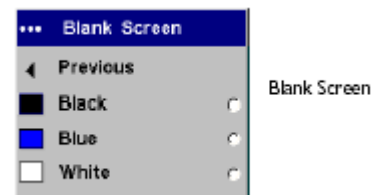
**Startup Logo:** allows you to display a blank Black, White, or Blue screen instead of the default screen at startup and when no source is detected. It also allows you to capture and display a custom startup screen.



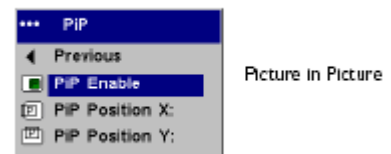
To capture a custom logo, display the image you want to capture on your computer, highlight **Capture New**, then press **Select** twice. When complete, the projector confirms the capture.

The next time you start the projector, the custom logo you captured displays.

**Blank Screen:** determines what color is displayed when you press the **Blank** button on the remote.



**PIP:** (Picture in Picture) allows you to overlay a smaller window showing the video source on top of the larger computer source window. You must have both a computer and video source connected to use PIP. You can't show a computer image in the smaller PiP window, only a video image. You can select a small, medium, or large window. You can also move the PiP window on the screen using the PiP Position X and Y options in the menu. Press the up and down arrows to change the position.



**Language:** allows you to select a language for the onscreen display of menus and messages.



**Service:** to use these features, highlight them and press **Select**.

**Factory Reset:** restores all settings (except Lamp Hours) to their default after displaying a confirmation dialog box.

**Lamp Reset:** resets the lamp hours counter in the **About** menu to zero. Do this only after changing the lamp. It displays a confirmation dialog box.

**Service Info:** provides information about the projector's software version and the active source.

**Service Code:** only used by authorized service personnel.

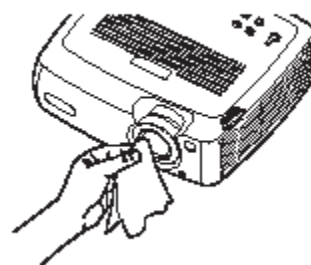


## Maintenance

### Cleaning the lens

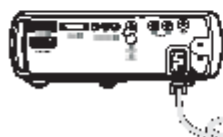
- 1 Apply a non-abrasive camera lens cleaner to a soft, dry cloth. Avoid using an excessive amount of cleaner, and don't apply the cleaner directly to the lens. Abrasive cleaners, solvents or other harsh chemicals might scratch the lens.
- 2 Lightly wipe the cleaning cloth over the lens in a circular motion. If you don't intend to use the projector immediately, replace the lens cap.

clean the lens  
with a soft dry cloth  
and non-abrasive  
cleaner



### Replacing the projection lamp

The lamp hour timer in the **About** menu counts the number of hours the lamp has been in use. When the lamp timer reaches the estimated total lamp life, the LED on the projector's keypad blinks red (indicating a lamp error, see page 26) and a dialog box appears each time the projector is turned on. You can order new lamp modules from your dealer.



turn off and unplug  
the projector

wait 60 minutes



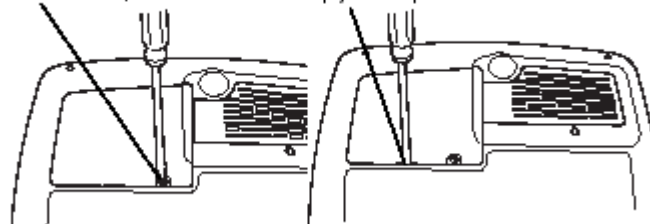
- 1 Turn off the projector and unplug the power cable.

- 2 Wait 60 minutes to allow the projector to cool thoroughly.

- 3 Turn the projector upside down and remove the lamp door by loosening the captive screw and then prying the lamp door out.

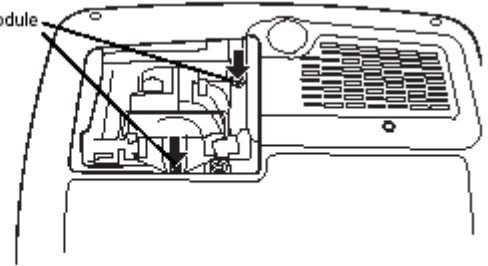
loosen the screw on lamp door

pry the lamp door off



**4** Remove the two screws on the lamp module.

remove the screws on lamp module

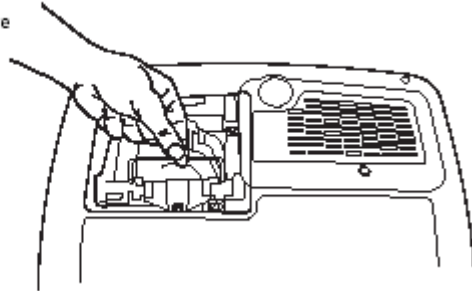


### WARNINGS:

- To avoid burns, allow the projector to cool for at least 60 minutes before you replace the lamp.
- Unplug the power cord before replacing the lamp.
- Do not drop the lamp module. The glass may shatter and cause injury.
- Do not touch the glass portion of the lamp module. Fingerprints can obscure projection sharpness.
- Be extremely careful when removing the lamp housing. In the unlikely event that the lamp ruptures, small glass fragments may be generated. The lamp module is designed to contain most of these fragments, but use caution when removing it. Before replacing the lamp, clean the lamp compartment and dispose of cleaning materials. Wash hands after lamp replacement. This product has a lamp, which contains a very small amount of mercury. Dispose of it as required by local, state or federal ordinances and regulations. For more information see [www.eiae.org](http://www.eiae.org).

**5** Carefully remove the lamp module by grasping and lifting the metal bail wire. Dispose of the lamp in an environmentally proper manner.

remove module using bail wire



**6** Install the new lamp module, making sure that it is properly seated (model SP17).

**7** Replace the two screws.

**8** Replace the lamp door and tighten the screw.

**9** Plug in the power cable then press the **Power** button to turn the projector back on.

**10** Reset the lamp hour timer by navigating to the **Settings>Service** menu and selecting **Lamp Reset**.

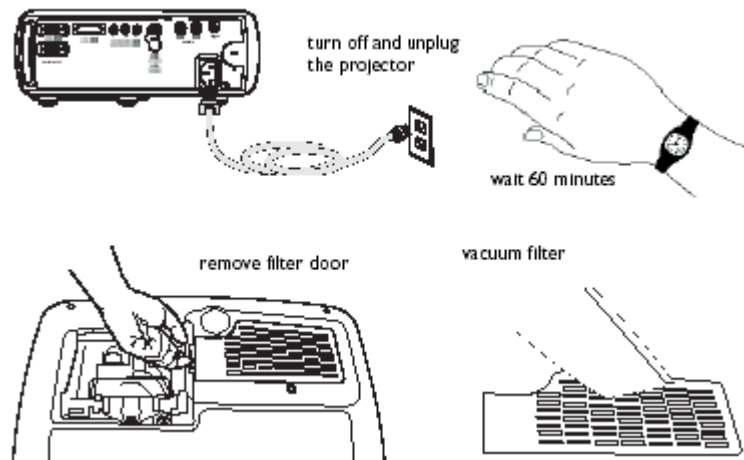


reset lamp time in Service menu



## Cleaning the dust filters

In dirty or dusty environments, the dust filters can become clogged, causing high temperatures inside the lamp module. These high temperatures can impact lamp performance and operating life. Routine maintenance to remove dust and dirt from the filters lowers the lamp operating temperature and prolongs lamp life. To maximize lamp life you will need to clean the filters every 250 hours. Lamp filter maintenance may need to occur more often than 250 hours depending on your installation/use environment.



There are two filters, one mesh filter attached to the dust filter door and one metal grid filter adjacent to the lamp door.

- 1 Turn off the projector and unplug the power cable.
- 2 Wait 60 minutes to allow the projector to cool thoroughly.

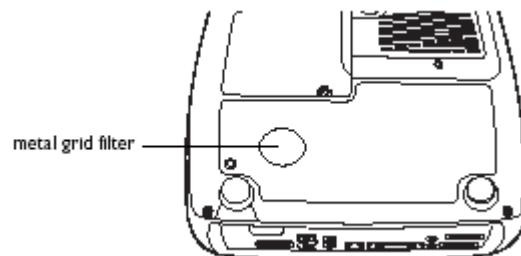
**WARNING:** To avoid burns, allow the projector to cool for at least 60 minutes before you clean or replace the dust filter.

- 3 Turn the projector upside down and remove the lamp door. See page 23.
- 4 Remove the dust filter door.

5 Clean the filter using a vacuum set on low power.

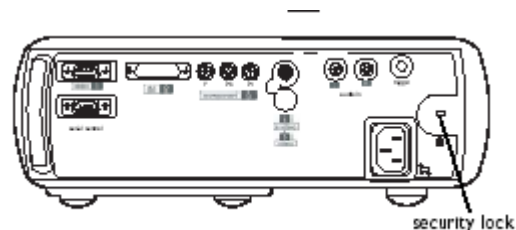
6 Replace the dust filter door and the lamp door.

7 Vacuum the non-removable metal grid filter adjacent to the lamp door.



## Using the security lock

The projector has a security lock for use with a cable lock system. Refer to the information that came with the lock for instructions on how to use it.



## Red LED behavior and projector errors

If the projector is not functioning properly and the red LED is blinking, consult **Table 2** to determine a possible cause. There are two-second pauses between the blinking cycles.

**Table 3:**

| <b>Red LED Behavior</b> | <b>Explanation</b>   |
|-------------------------|--|
| One (1) blink           | The lamp won't strike after five attempts. Check the lamp and lamp door installations for loose connectors.  |
| Two (2) blinks          | The lamp counter hours have exceeded lamp life hours. Replace the lamp and reset the lamp hours counter.   |
| Three (3) blinks        | The projector has shut down the lamp. Turn the projector off and wait one minute, then turn the on. If the lamp does not turn on, replace the lamp. Contact Technical Support for repair if replacing the lamp does not solve the problem. |
| Four (4) blinks         | A fan has failed. Contact Technical Support for repair.  |
| Five (5) blinks         | The projector is overheating. Check for a blocked air vent. Contact Technical Support for repair if clearing The air vent does not solve the problem.  |

## Projected image size

**Table 4:  
Image sizes**

| <b>Distance to screen (feet/m)</b> | <b>Minimum Diagonal (feet/m) throw ratio 1.72</b> | <b>Maximum Diagonal (feet/m) throw ratio 1.44</b> | <b>Minimum Horizontal (feet/m) throw ratio 1.98</b> | <b>Maximum Horizontal (feet/m) throw ratio 1.98</b> |
|------------------------------------|---|---|---|---|
| 5/1.5                              | 2.9/0.9   | 3.5/1.1   | 2.6/0.8   | 3.1/0.9   |
| 10/3                               | 5.8/1.8   | 6.9/2.1   | 5.1/1.5   | 6.0/1.8   |
| 15/4.6                             | 8.7/2.6   | 10.4/3.2  | 7.6/2.3   | 9.0/2.8   |
| 20/6.1                             | 11.6/3.5  | 13.8/4.2  | 10.1/3.1  | 12.0/3.7  |
| 30/9.1                             | 17.3/5.3  | 20.6/6.3  | 15.1/4.6  | 18.0/5.5  |
| 32.8/10                            | 18.9/5.8  | 22.6/6.9  | 16.5/5.0  | 19.7/6.0  |

For more information, go to [www.knollsystems.com/lcd225.htm](http://www.knollsystems.com/lcd225.htm).

### **Limited Warranty**

Knoll Systems, Inc. ("Knoll") warrants that each HD225 ("the Product") sold hereunder will conform to and function in accordance with the written specifications of Knoll. Said limited warranty shall apply only to the first person or entity that purchases the Product for personal or business use and not for the purpose of distribution or resale. Said warranty shall continue for a period of two (2) years from the date of such purchase. The standard limited warranty excludes the lamps in projectors after 90 days or 500 hours and the accessories after one year. Knoll does not warrant that the Product will meet the specific requirements of the first person or entity that purchases the Product for personal or business use. Knoll' liability for the breach of the foregoing limited warranty is limited to the repair or replacement of the Product or refund of the purchase price of the Product, at Knoll' sole option. Replacement Product may be re-furbished in "like-new" condition, at Knoll' sole discretion. To exercise the Purchaser's rights under the foregoing warranty, the Product must be returned at the Purchaser's sole cost and expense, to Knoll or to any authorized Knoll service center provided, and the Product must be accompanied by a written letter explaining the problem and which includes (i) proof of date of purchase; (ii) the dealer's name; and (iii) the model and serial number of the Product. When sending your unit in for repair, please ship your unit in its original packing material or a Knoll approved ATA Shipping Case, or have a professional packaging company pack the unit. Please insure your shipment for its full value. A return authorization number, issued by the Knoll customer service department, must also be clearly displayed on the outside of the shipping carton containing the Product.

Note: Remanufactured Products are exempt from the foregoing Limited Warranty. Please refer to the Remanufactured Product Warranty for applicable warranty information.

### **WARRANTY LIMITATION AND EXCLUSION**

Knoll shall have no further obligation under the foregoing limited warranty if the Product has been damaged due to abuse, misuse, neglect, accident, unusual physical or electrical stress, unauthorized modifications, tampering, alterations, or service other than by Knoll or its authorized agents, causes other than from ordinary use or failure to properly use the Product in the application for which said Product is intended.

### **DISCLAIMER OF UNSTATED WARRANTIES**

THE WARRANTY PRINTED ABOVE IS THE ONLY WARRANTY APPLICABLE TO THIS PURCHASE. ALL OTHER WARRANTIES, EXPRESS OR IMPLIED, INCLUDING, BUT NOT LIMITED TO, THE IMPLIED WARRANTIES OF MERCHANTABILITY AND FITNESS FOR A PARTICULAR PURPOSE ARE DISCLAIMED. THERE ARE NO WARRANTIES THAT EXTEND BEYOND THE FACE HEREOF AND THE FOREGOING WARRANTY SHALL NOT BE EXTENDED, ALTERED OR VARIED EXCEPT BY WRITTEN INSTRUMENT SIGNED BY KNOLL. SOME STATES DO NOT ALLOW LIMITATIONS ON HOW LONG AN IMPLIED WARRANTY MAY LAST, SO SUCH LIMITATIONS MAY NOT APPLY TO YOU.

### **LIMITATION OF LIABILITY**

IT IS UNDERSTOOD AND AGREED THAT KNOLL' LIABILITY WHETHER IN CONTRACT, IN TORT, UNDER ANY WARRANTY, IN NEGLIGENCE OR OTHERWISE SHALL NOT EXCEED THE RETURN OF THE AMOUNT OF THE PURCHASE PRICE PAID BY PURCHASER AND UNDER NO CIRCUMSTANCES SHALL KNOLL BE LIABLE FOR SPECIAL, INDIRECT, INCIDENTAL OR CONSEQUENTIAL DAMAGES OR LOST PROFITS, LOST REVENUES OR LOST SAVINGS. THE PRICE STATED FOR THE PRODUCT IS A CONSIDERATION IN LIMITING KNOLL' LIABILITY. NO ACTION, REGARDLESS OF FORM, ARISING OUT OF THE AGREEMENT TO PURCHASE THE PRODUCT MAY BE BROUGHT BY PURCHASER MORE THAN ONE YEAR AFTER THE CAUSE OF ACTION HAS ACCRUED. SOME STATES DO NOT ALLOW THE EXCLUSION OR LIMITATION OF INCIDENTAL OR CONSEQUENTIAL DAMAGES SO THE ABOVE LIMITATION OR EXCLUSION MAY NOT APPLY TO YOU. THIS LIMITED WARRANTY GIVES YOU SPECIFIC LEGAL RIGHTS, AND YOU MAY ALSO HAVE OTHER RIGHT WHICH VARIES FROM STATE TO STATE.

© Copyright 2004 Knoll Systems. All Rights Reserved.

Knoll Systems  
11791 Machrina Way #210  
Richmond, BC V7A 4V3  
Canada  
[www.knollsystems.com](http://www.knollsystems.com)